

# GALTAROSS ALLUMINIO

PROFILI SPECIALI

## CATALOGO PROFILI



[www.galtarossalluminio.com](http://www.galtarossalluminio.com)

## PROPRIETA' FISICHE PHYSICAL PROPERTIES

LEGA ALLOY	DENSITA' DENSITY Kg/dm <sup>3</sup>	MODULO DI ELASTICITA' MODULUS OF ELASTICITY kN/mm <sup>2</sup>	COEFFICIENTE DI DILATAZIONE TERMICA THERMAL EXPANSION COEFFICIENT μ°C <sup>-1</sup> 20-100°C	CONDUCIBILITA' TERMICA THERMAL CONDUCTIVITY W/(m-K) 20°C	CALORE SPECIFICO SPECIFIC HEAT J/(Kg-k) 0-100°C	RESISTIVITA' RESISTIVITY n Ω μ	RANGE TEMPERATURA DI FUSIONE MELTING TEMPERA- TURE RANGE °C
6060	2.70	69	23	200	880-900	33	600-655
6063	2.70	69	23	200	880-900	33	600-655
6005A	270	69	23.3	182	960	36	605-655
6463	2.70	67	24	195	850	33	610-650
6082	2.71	69	23	180	897	38	580-650
6101	2.70	69	24	218	895	30	620-655

## COMPARAZIONE LEGHE ALLOY COMPARISON

DESIGNAZIONE NUMERICA IDENTIFICATION NUMBER	D		USA	I	
	DIN	DIN Werkstoff Nr	AA	UNI	
6060	Al Mg Si 0,5	3.3206	6060	3569	9006/1
6060	Al Mg Si 0,5	3.3206	6060	3569	9006/1
6005A	Al Mg Si 0,7	3.3210	6005A		9006/6
6463	Al Mg Si 0,5	3.3206	6463	6359	9006/5
6082	Al Mg Si 1	3.2315	6082	3571	9006/4
6101	E Al Mg Si 0,5	3.3207	6101	3570	9006/3

## CARATTERISTICHE MECCANICHE MECHANICAL SPECIFICATIONS

DESIGNAZIONE NUMERICA IDENTIFICATION NUMBER	STATO DI FORNITURA STATE OF SUPPLY	CARATTERISTICHE MECCANICHE MIN MIN MECHANICAL SPECIFICATIONS			
		Rm N/mm <sup>2</sup>	Rp (02) N/mm <sup>2</sup>	A%	HB
6060	F	120	70	22	40
	T4	130	80	16	45
	T5	185	145	11	55-70
	T6	205	165	10	60-80
6063	T6	245	195	10	75
	T6	245	195	10	75
6005A	T4	160	90	14	45
	T6	260	215	8	80
6463	T4	130	80	16	45
	T5	185	145	11	55-70
	T6	275	200	12	85
6082	F	150	-	16	45
	T4	205	110	14	50
	T6	275	200	12	85
	T6	310	260	10	95
6101	F	120	-	15	40
	T4	150	80	14	45
	T6	210	180	12	65

## COMPOSIZIONE CHIMICA % CHEMICAL COMPOSITION %

DESIGNAZIONE NUMERICA IDENTIFICATION NUMBER	Al	Mg	Si	Fe	Mn	Zn	Cu	IMPURITA' IMPURITIES
6060	Resto	0,30-0,60	0,30-0,60	0,30	0,10	0,10	0,10	0,05-0,15
6063	Resto	0,40-0,65	0,40-0,65	0,30	0,10	0,10	0,10	0,05-0,15
6005A	Resto	0,40-0,70	0,50-0,90	0,30	0,10	0,10	0,30	0,05-0,15
6463	Resto	0,40-0,65	0,30-0,50	0,13	0,05	0,10	0,05-0,20	0,02-0,10
6082	Resto	0,60-1,20	0,70-1,30	0,30	0,40-1,00	0,10	0,10	0,05-0,15
6101	Resto	0,40-0,60	0,35-0,60	0,30	0,03	0,05	0,05	0,05-0,15

N.B. Tutti i dati riportati sul presente catalogo sono indicativi e non impegnativi. La società si riserva la facoltà di apportare in qualsiasi momento cambiamenti atti a migliorare i prodotti.

NOTE: All the details shown in this catalogue are approximate and not binding. The company reserves the right to make any changes at any time for the purpose of upgrading its products.

## TUBI TONDI

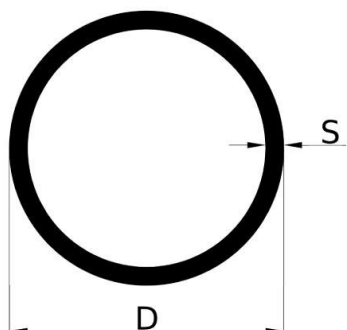

### LEGA EN AW - 6060

D ( mm )	S ( mm )	Kg/ml	Lunghezza Barre (mm)
10	1	0,075	6000
13	1,5	0,146	6000
16	1,5	0,183	6000
20	2	0,305	6200
22	2	0,339	6000
25	1,5	0,299	6000
30	1,5	0,362	6000
32	1,5	0,391	6000
35	1,5	0,427	6000
40	1,5	0,489	6000
50	2	0,813	7000
60	1,5	0,742	7000
60	2	0,982	6000
70	1,5	0,872	7000/5000
100	3	2,467	6000

# **TUBI QUADRI**

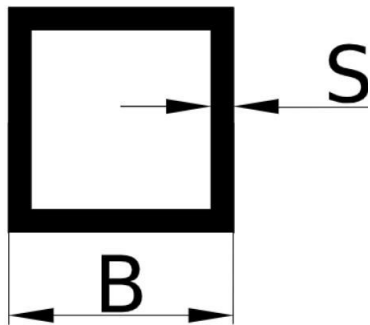

## **LEGA EN AW - 6060**

<b>B ( mm )</b>	<b>S ( mm )</b>	<b>Kg/ml</b>	<b>Lunghezza Barre (mm)</b>
15	1,5	0,219	6000
20	1,5	0,295	6000
25	1,2 Ragg 1,5	0,307	6000
25	1,5	0,380	6000
30	1,5	0,480	6000
35	1,5	0,543	6000
40	1,5	0,635	6000
40	2	0,820	6000
45	2	0,929	6000
50	2	1,037	6000
60	2	1,253	6000
70	2	1,469	6000
80	2	1,685	6000
100	2	2,117	6000
120	2,5	3,172	7000
150	3	4,763	6000
200	4 Ragg 10	8,570	6000

# TUBI RETTANGOLARI

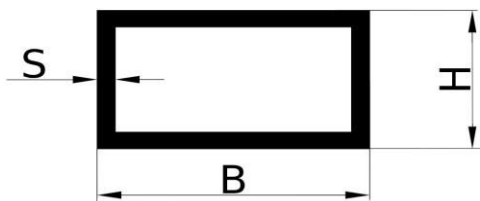

## LEGA EN AW - 6060

B ( mm )	H ( mm )	S ( mm )	Kg/ml	Lunghezza Barre (mm)
20	10	1,5	0,219	6000
30	20	1,5	0,381	6000
40	15	1,5	0,421	6000
40	20	1,5	0,462	6000
40	20	2	0,605	6000
40	20	2 Raggio 2	0,630	6000
40	25	2	0,659	6000
40	30	1,5	0,550	6000
50	20	1,5	0,543	6000
50	20	2	0,713	6000
50	20	2 Raggio 2	0,717	6000
50	25	2	0,766	6000
50	30	2	0,820	6000
60	20	2	0,821	6000
60	40	2	1,037	6000
100	30	2	1,361	7000
100	40	2	1,469	7000
100	50	2	1,570	6000
100	50	3	1,437	6000
120	20	2	1,468	6000
120	40	2	1,685	7000
120	50	4	3,440	6000
120	60	4	3,715	6000
150	50	2	2,116	7000
200	40	2	2,549	7000
200	50	3	3,952	6000
200	100	3	4,762	6500

## ANGOLARI LATI DISUGUALI

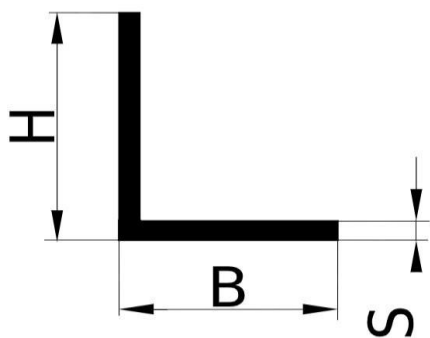

**LEGA EN AW - 6060**

<b>B ( mm )</b>	<b>H ( mm )</b>	<b>S ( mm )</b>	<b>Kg/ml</b>	<b>Lunghezza Barre (mm)</b>
30	10	2	0,206	7000
30	15	1,5	0,189	6000
30	15	2	0,233	6000
30	20	2	0,260	6000
40	20	2	0,314	6000
50	20	2	0,367	6000
50	25	2	0,395	6000
50	40	2	0,476	6000
80	40	2	0,637	6000
100	20	2	0,638	6000
100	30	2	0,702	6000
100	50	2	0,800	6000
120	20	2	0,746	6000

**BARRE PIATTE**

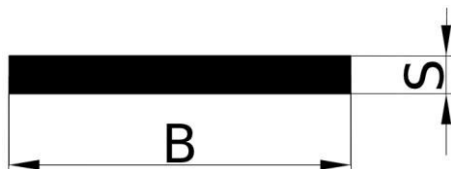

B ( mm )	S ( mm )	Kg/ml	Lunghezza Barre (mm)
20	2	0,108	6000
25	3	0,203	5600
25	4	0,270	6000
25	5	0,337	6000
25	6	0,405	6000
30	2	0,162	6500
30	4	0,324	6000
30	5	0,405	6000
30	6	0,486	6000

**PROFILI AD U**

**LEGA EN AW - 6060**

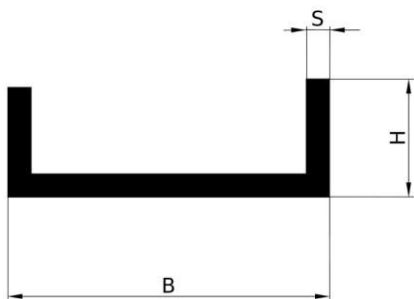

B ( mm )	H ( mm )	S ( mm )	Kg/ml	Lunghezza Barre (mm)
20	30	2	0,410	7000
25	25	2	0,383	6000
30	30	2	0,465	6000
40	40	2	0,630	6000
50	25	2	0,520	6000
80	50	3	1,409	6000

**PROFILI T**

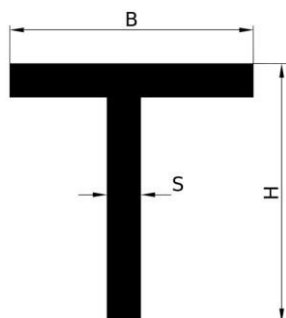

**LEGA EN AW - 6060**

B ( mm )	H ( mm )	S ( mm )	Kg/ml	Lunghezza Barre (mm)
119	51	2	0,907	6000

# PROFILI PER TENDE DA SOLE

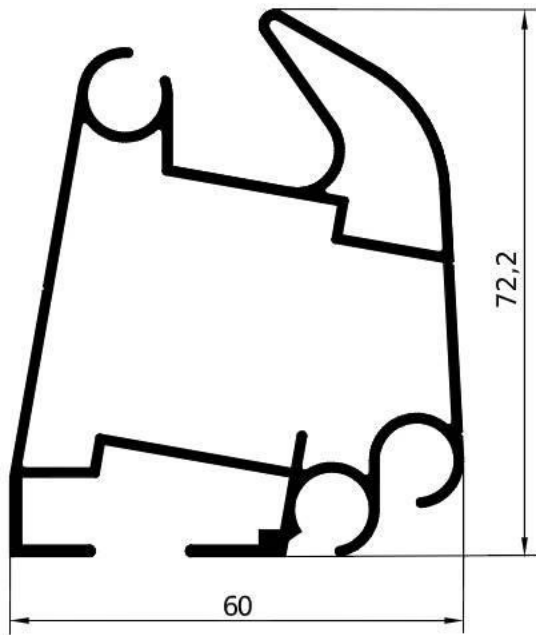

**GA1051 – gr/ml 1241**  
 L/mm. 4000-4500-5000-  
 5500-6000-6500-7000  
 PACCO / 2 BARRE

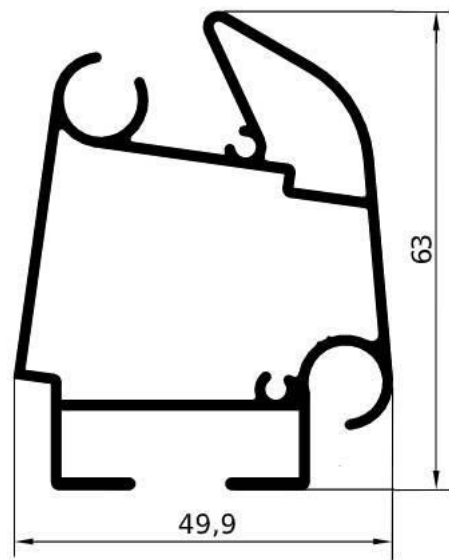

**GA1050 – gr/ml 1037**  
 L/mm. 4000-5000  
 6000-7000  
 PACCO / 2 BARRE

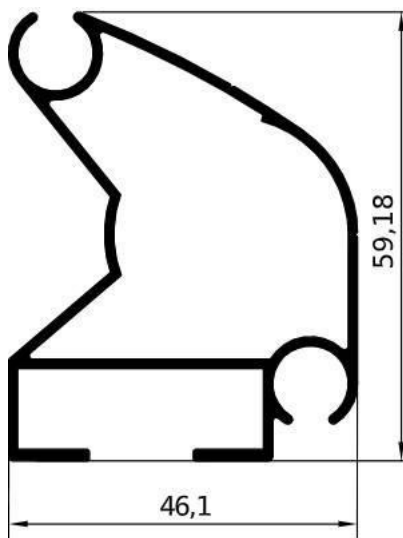

**GA1510 – gr/ml 800**  
 L/mm. 4000-5000  
 6000-7000  
 PACCO / 2 BARRE

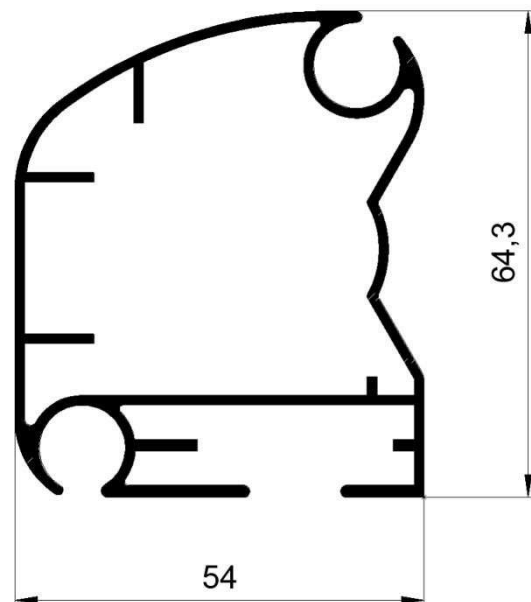

**GA1053 – gr/ml 1196**  
 L/mm. 4000-5000  
 6000-7000  
 PACCO / 2 BARRE



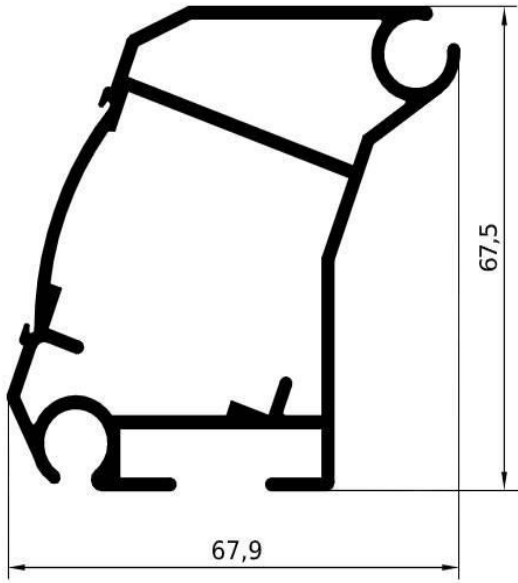

<b>GA1004 – gr/ml 1453</b>
L/mm. 4000-5000 6000-7000
SU ORDINAZIONE

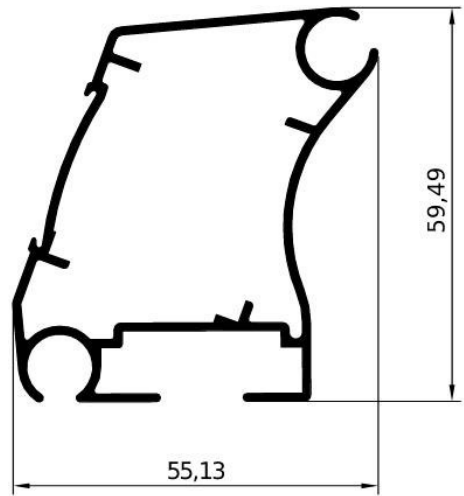

<b>GA1669 – gr/ml 886</b>
L/mm. 4000-5000 6000-7000
SU ORDINAZIONE

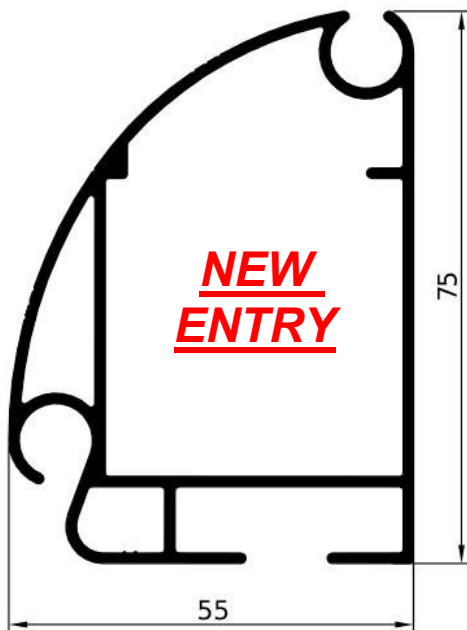

<b>GA1694 – gr/ml 1306</b>
L/mm. 4000-5000 6000-7000
PACCO / 2 BARRE

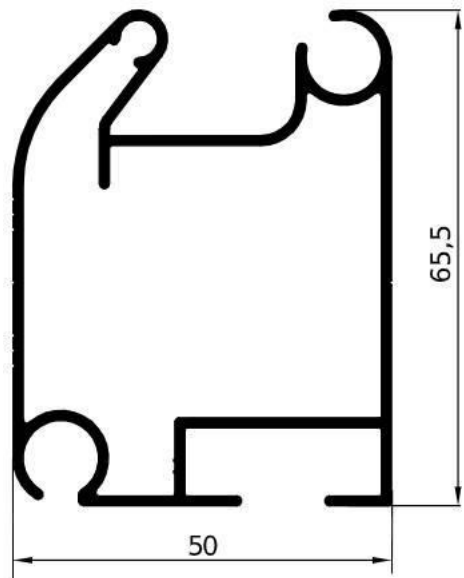

<b>GA1515 – gr/ml 1078</b>
L/mm. 4000-5000 6000-7000
PACCO / 2 BARRE

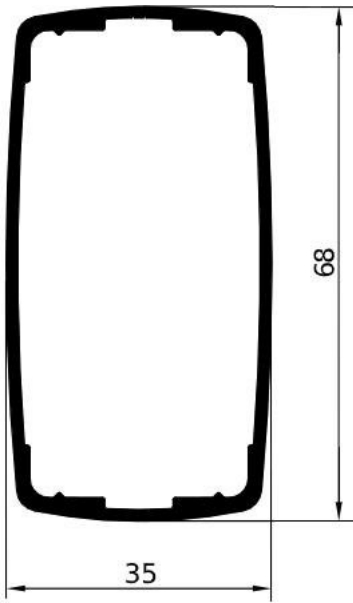

<b>GA1508 – gr/ml 906</b>
L/mm.7000
PACCO / 2 BARRE

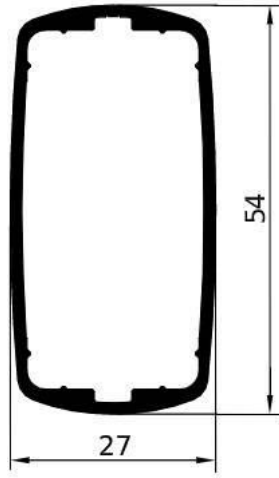

<b>GA1501 – gr/ml 702</b>
L/mm. 7000
PACCO / 2 BARRE

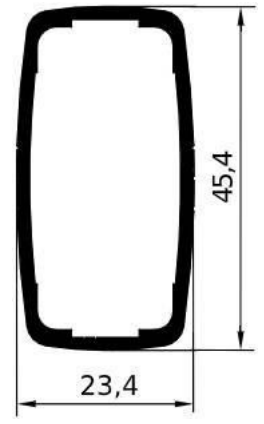

<b>GA1507 – gr/ml 581</b>
L/mm. 7000
PACCO / 2 BARRE

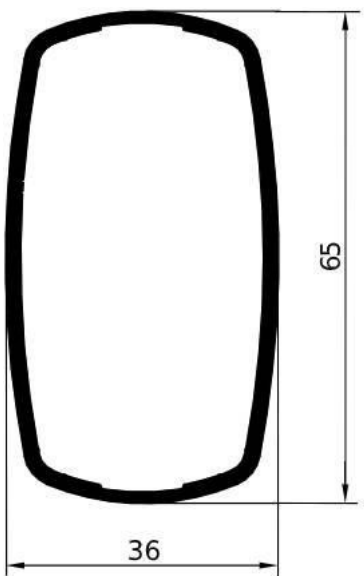

<b>GA1511 – gr/ml 899</b>
L/mm.7000
PACCO / 2 BARRE

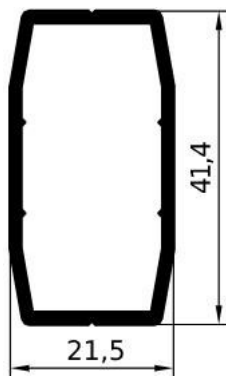

<b>GA1677 – gr/ml 450</b>
L/mm.6000
PACCO / 5 BARRE

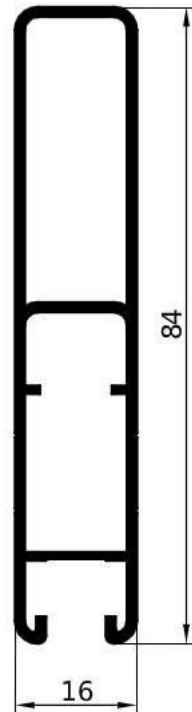

<b>GA1517 – gr/ml 701</b>
L/mm.6000
PACCO / 5 BARRE

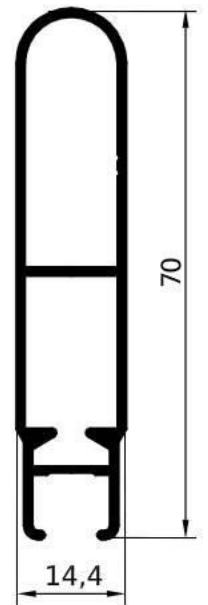

<b>GA1607 – gr/ml 491</b>
L/mm.6000
PACCO / 5 BARRE

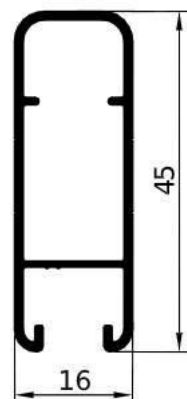
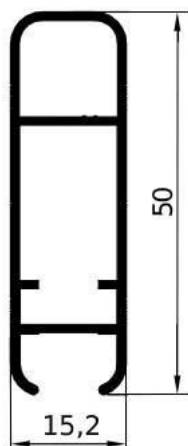
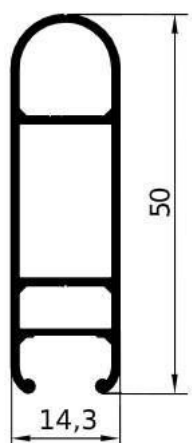
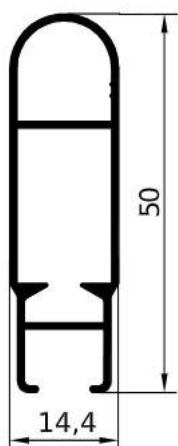

**GA1005 – gr/ml 410**

L/mm.7000

PACCO / 5 BARRE

**GA1001 – gr/ml 410**

L/mm.7000

PACCO / 5 BARRE

**GA1003 – gr/ml 440**

L/mm.7000

PACCO / 5 BARRE

**GA1006 – gr/ml 400**

L/mm.7000

PACCO / 5 BARRE

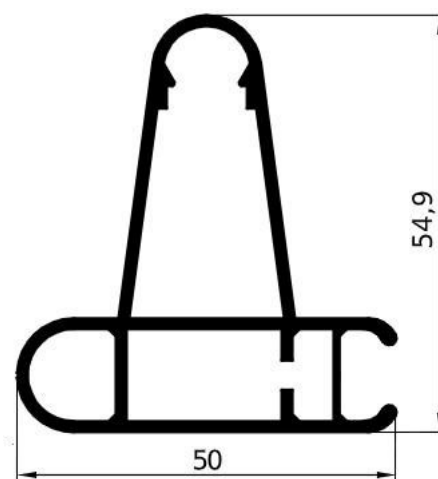
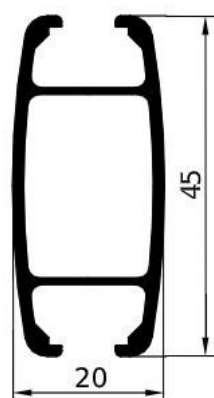
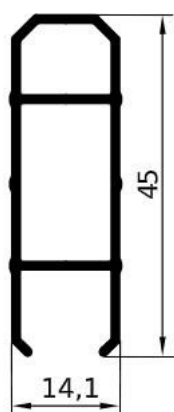
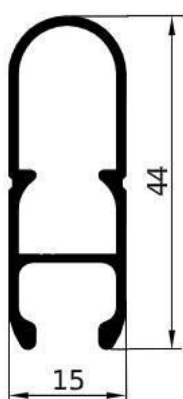

**GA1007 – gr/ml 380**

L/mm.7000

PACCO / 5 BARRE

**GA1008 – gr/ml 340**

L/mm.7000

PACCO / 5 BARRE

**GA1577 – gr/ml 518**

L/mm. Su richiesta

PACCO / 5 BARRE

**GA1573 – gr/ml 823**

L/mm.7000

PACCO / 4 BARRE

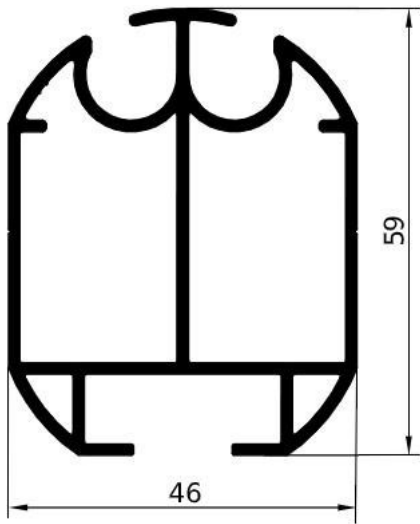

<b>GA1553 – gr/ml 1253</b>
L/mm.7000
PACCO / 2 BARRE

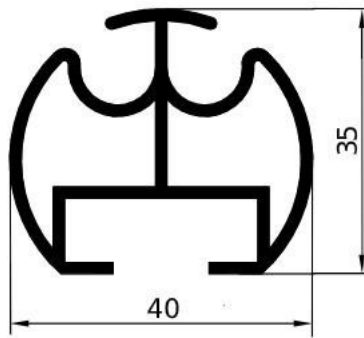

<b>GA1558 – gr/ml 801</b>
L/mm.7000
PACCO / 5 BARRE

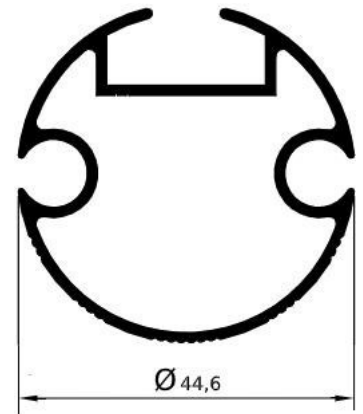

<b>GA1512 – gr/ml 702</b>
L/mm.5000-6000-7000
PACCO / 5 BARRE

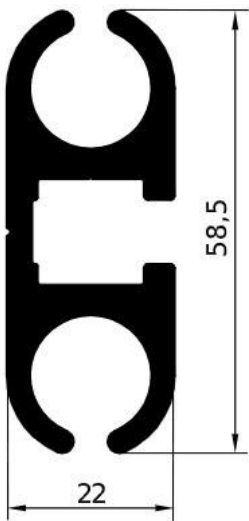

<b>GA1526 – gr/ml 1479</b>
L/mm.7000
PACCO / 4 BARRE

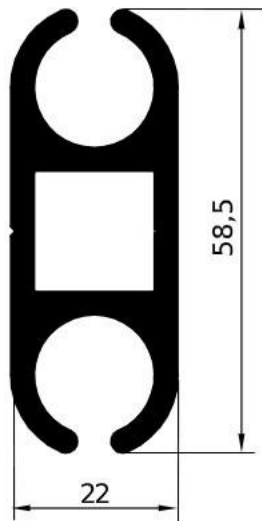

<b>GA1052 – gr/ml 1425</b>
L/mm.7000
PACCO / 4 BARRE

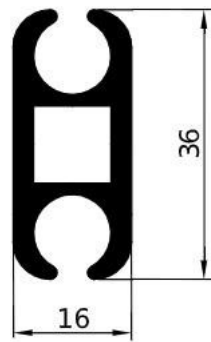

<b>GA1599 – gr/ml 694</b>
L/mm.7000
PACCO / 5 BARRE

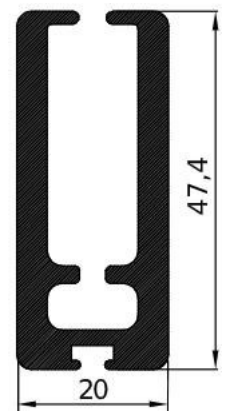

<b>GA1638 – gr/ml 1245</b>
L/mm.7000
PACCO / 4 BARRE

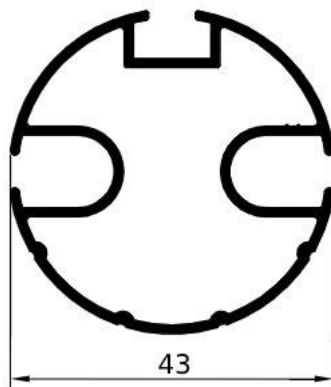

**GA1525 – gr/ml 662**  
 L/mm.4000-5000-  
 6000-7000  
 PACCO / 5 BARRE

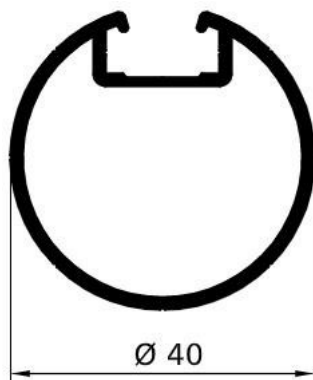

**GA1556 – gr/ml 558**  
 L/mm.Su richiesta  
 PACCO / 5 BARRE

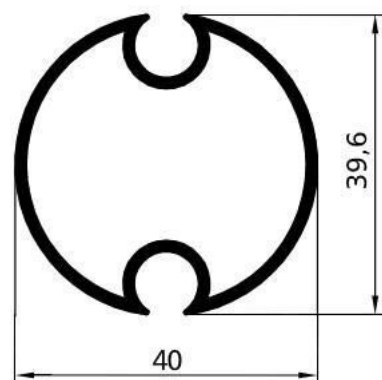

**GA1539 – gr/ml 612**  
 L/mm.7000  
 PACCO / 5 BARRE

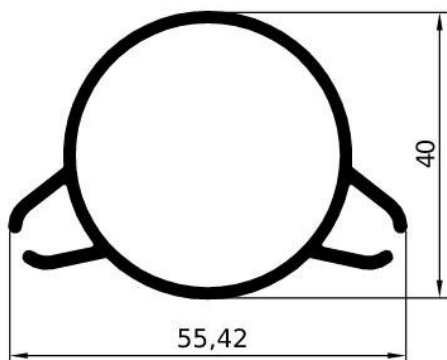

**GA1513 – gr/ml 609**  
 L/mm.7000  
 PACCO / 5 BARRE

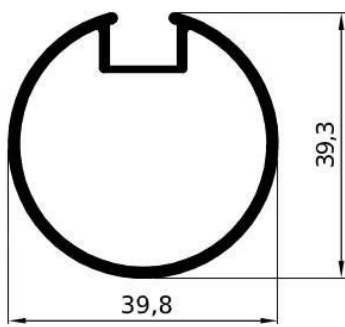

**GA1002 – gr/ml 530**  
 L/mm.7000  
 PACCO / 5 BARRE

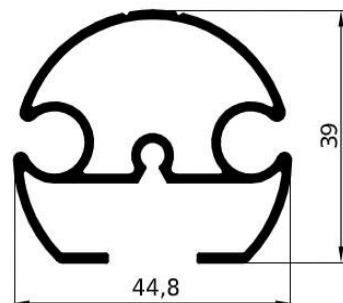

**GA1055 – gr/ml 679**  
 L/mm.5000-7000  
 PACCO / 5 BARRE

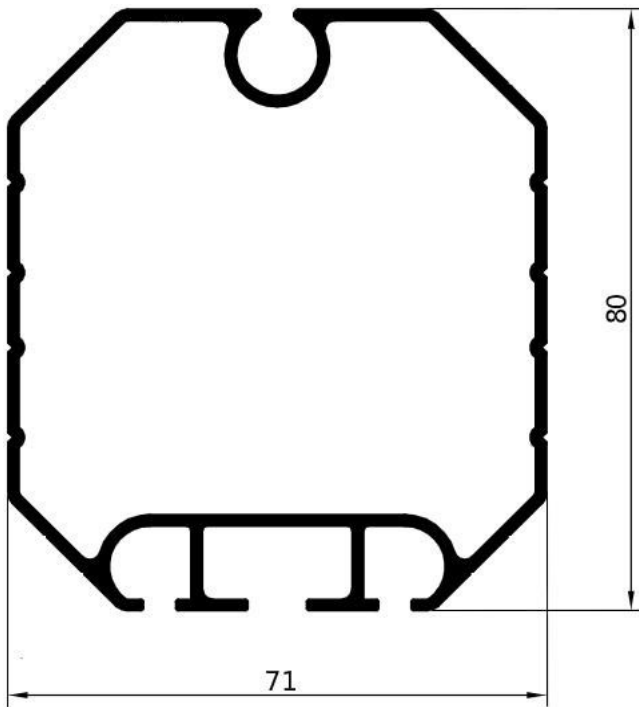

<b>GA1522 – gr/ml 1250</b>
L/mm.7000
PACCO / 2 BARRE

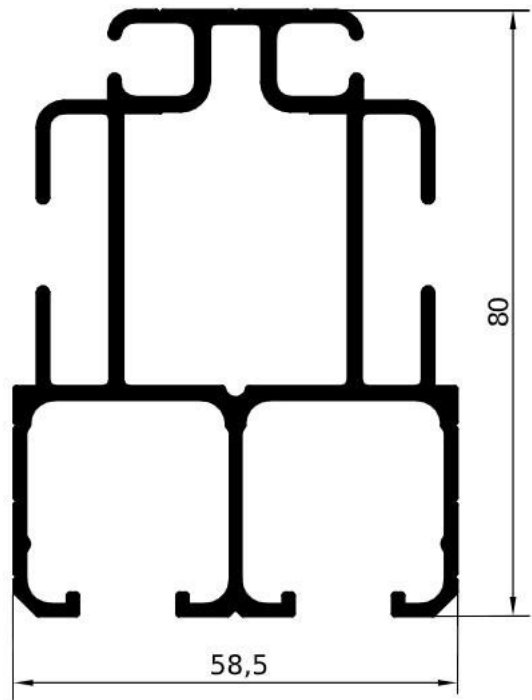

<b>GA1523 – gr/ml 1786</b>
L/mm.7000
PACCO / 2 BARRE

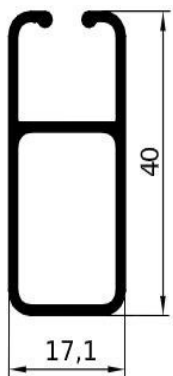

<b>GA1054 – gr/ml 386</b>
L/mm.6000
PACCO / 5 BARRE

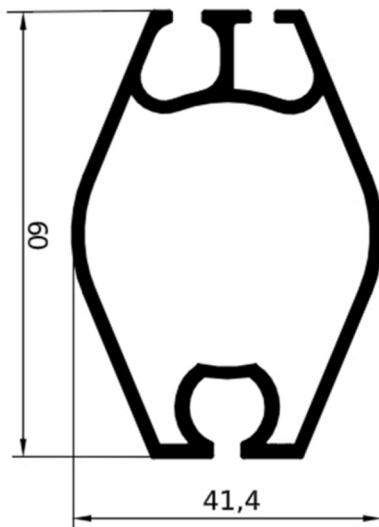

<b>GA1528 – gr/ml 852</b>
L/mm. 7000
PACCO / 3 BARRE

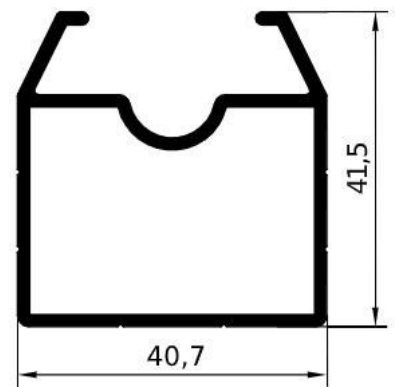

<b>GA1519 – gr/ml 686</b>
L/mm.7000
PACCO / 3 BARRE

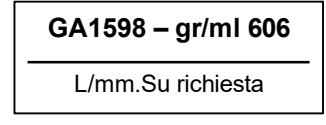
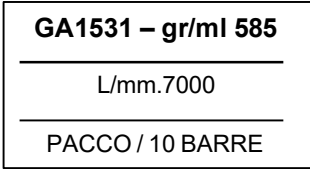
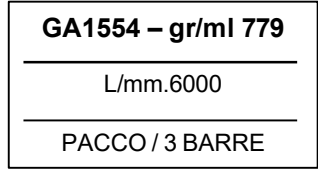
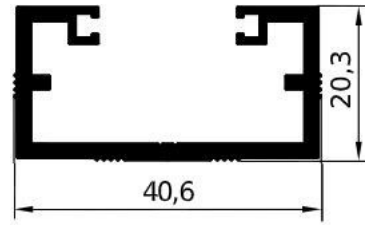
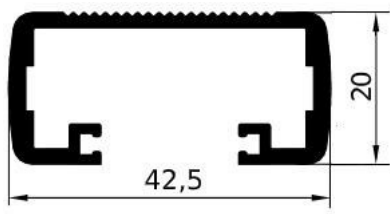
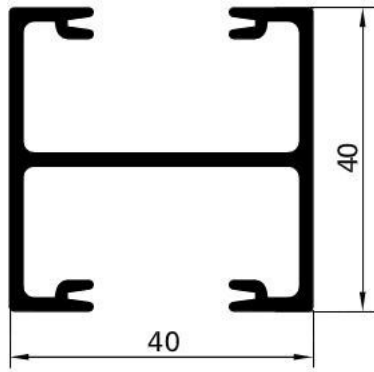
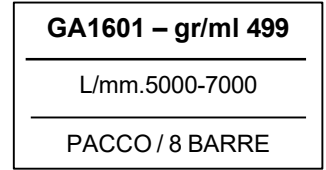
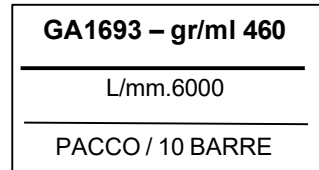
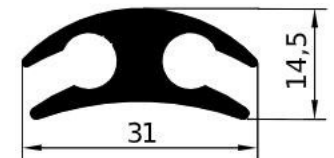
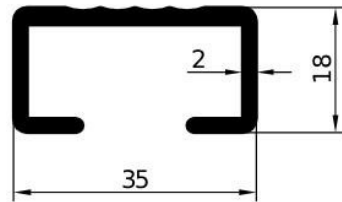
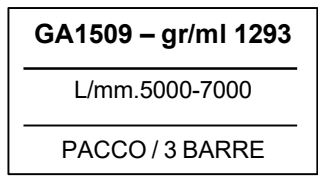
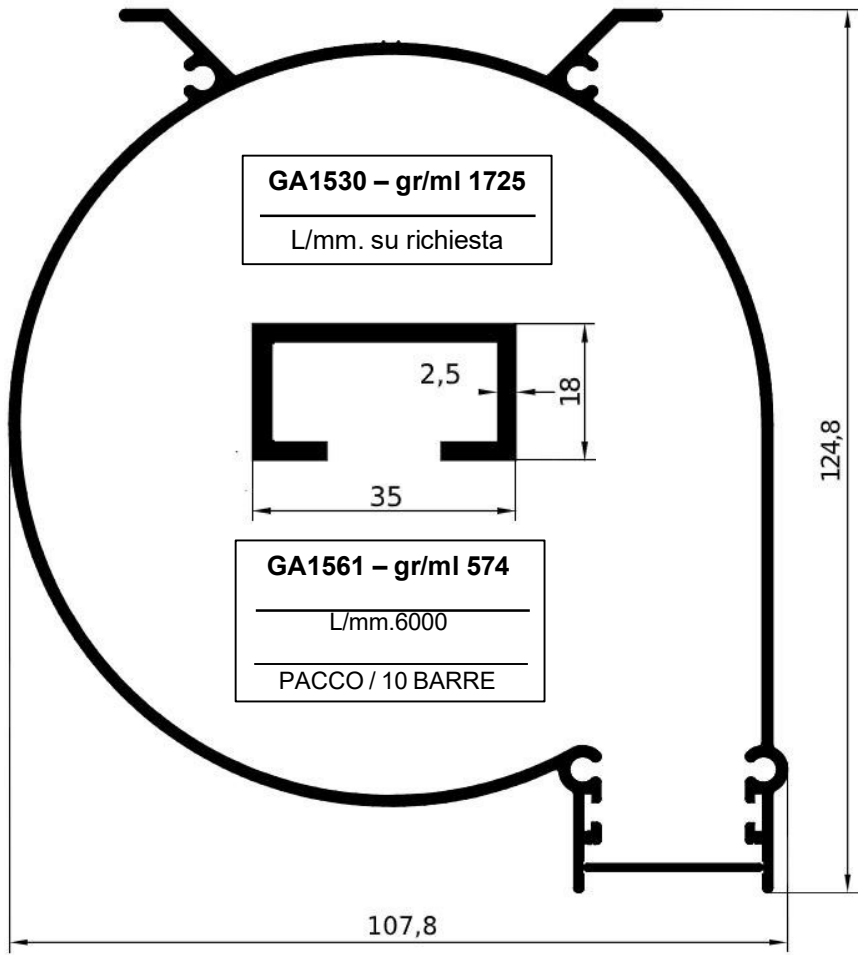
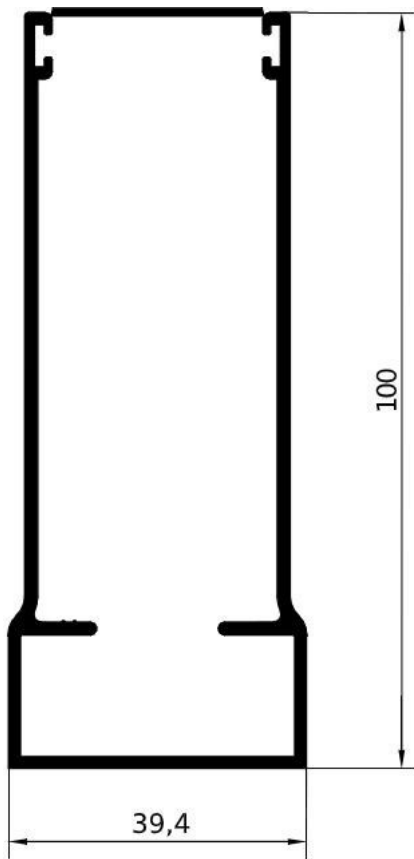

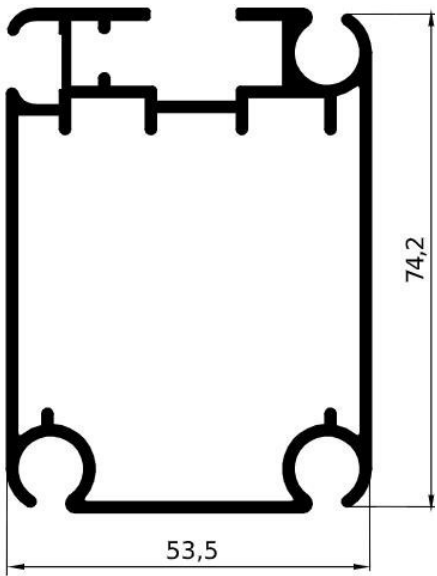

**GA1602 – gr/ml 1350**  
 L/mm.5000 - 7000  
 PACCO / 2 BARRE

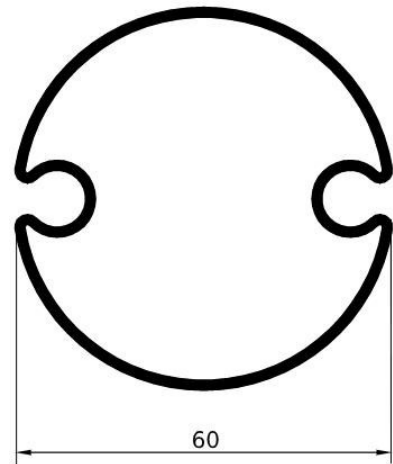

**GA1603 – gr/ml 921**  
 L/mm.7000  
 PACCO / 3 BARRE

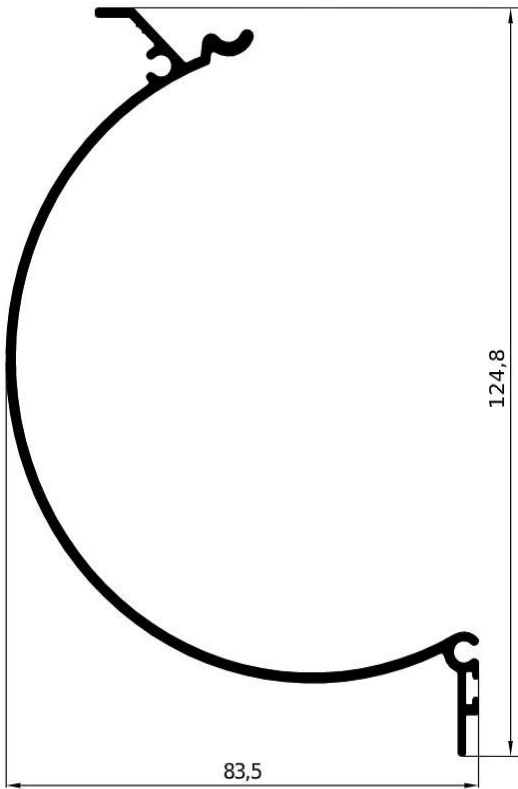

**GA1622 – gr/ml 1028**  
 L/mm.5000-7000  
 PACCO / 2 BARRE

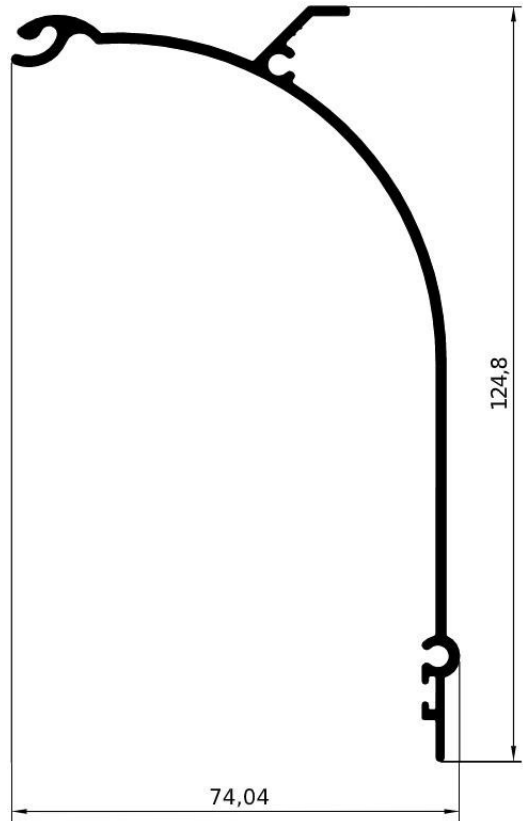

**GA1621 – gr/ml 920**  
 L/mm.5000-7000  
 PACCO / 2 BARRE



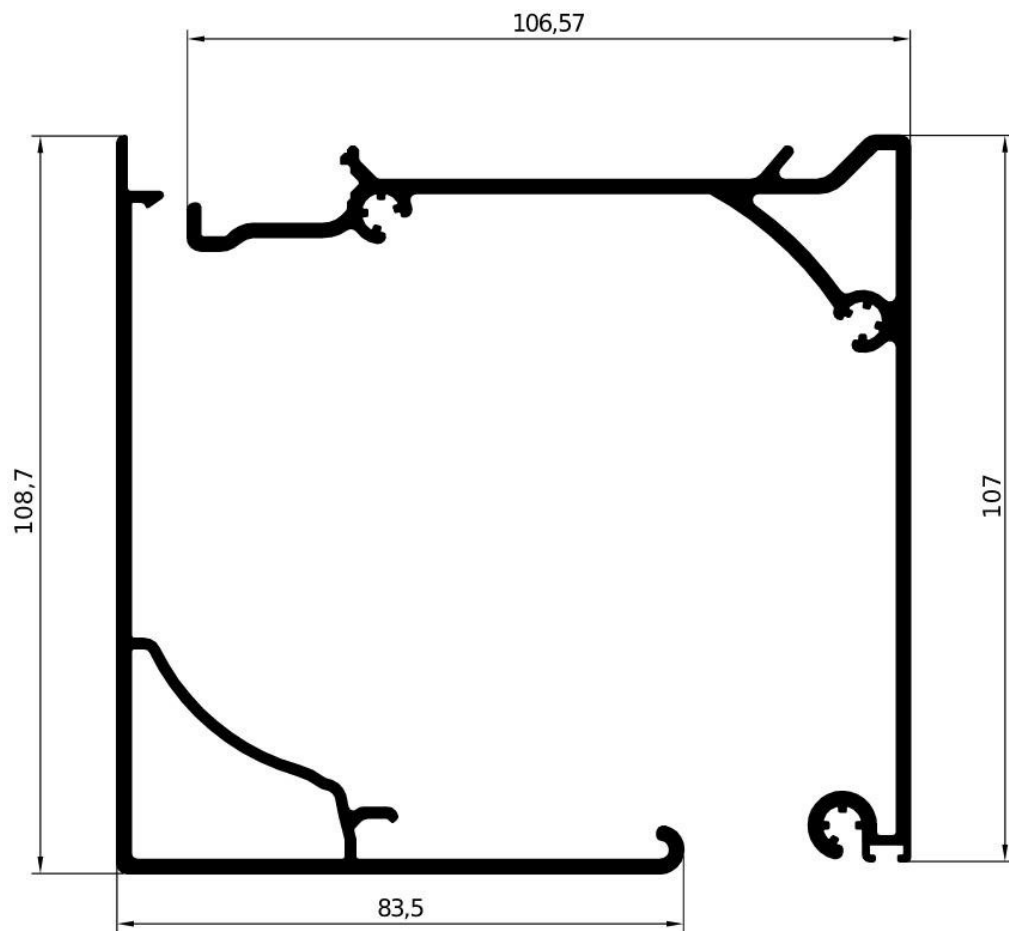

<b>GA1683 – gr/ml 1282 CASS VEGA</b>
L/mm.7000
PACCO / 1 BARRA

<b>GA1684 – gr/ml 1697 CASS VEGA</b>
L/mm.7000
PACCO / 1 BARRA

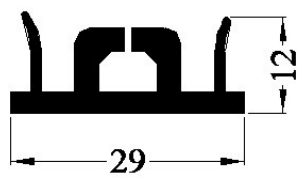
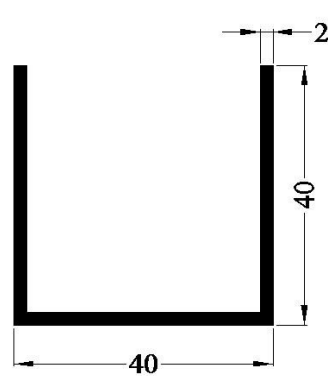
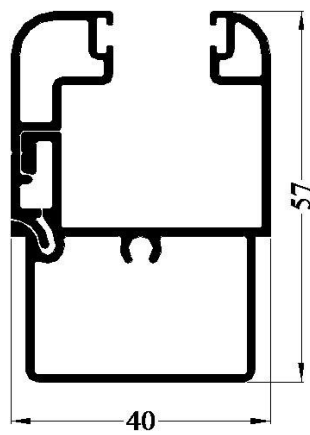

<b>AC135 – Kit Guida Zip</b>
L/ mm.6000
PACCO / 1 BARRA

<b>AC135/A – GUIDA ZIP mm.29 PER AC135</b>
L/ mm.6000
PACCO / 1 BARRA

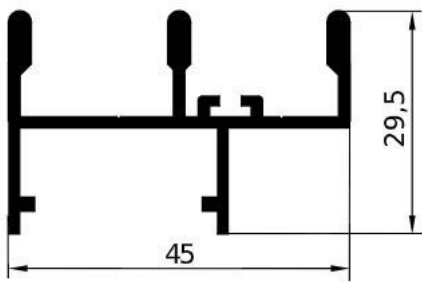

**GA1536 – gr/ml 607**  
 L/mm.6500  
 PACCO / 10 BARRE

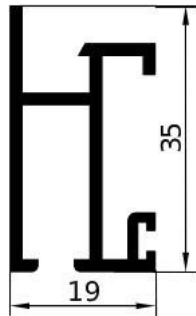

**GA1537 – gr/ml 424**  
 L/mm.6500  
 PACCO / 10 BARRE

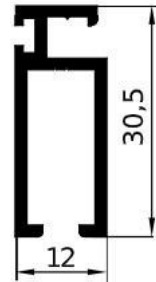

**GA1538 – gr/ml 324**  
 L/mm.6500  
 PACCO / 10 BARRE

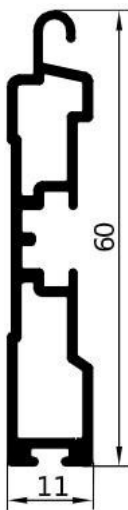

**GA1624 – gr/ml 470**  
 L/mm.6200  
 PACCO / 5 BARRE

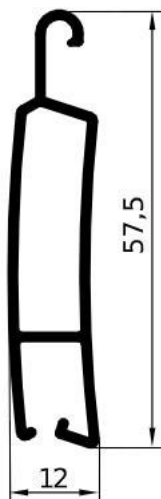

**GA1514 – gr/ml 351**  
 L/mm.6000  
 PACCO / 5 BARRE

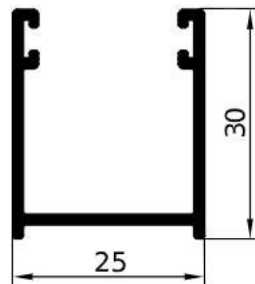

**GA1625 – gr/ml 303**  
 L/mm.6500  
 PACCO / 10 BARRE

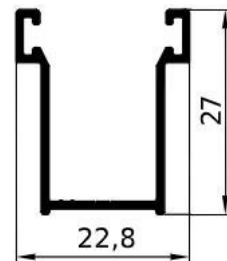

**GA1626 – gr/ml 218**  
 L/mm.6500  
 PACCO / 10 BARRE

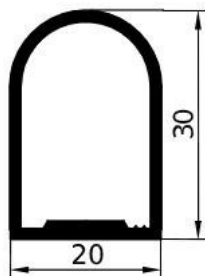

**GA1606 – gr/ml 378**  
 L/mm.5200  
 PACCO / 10 BARRE

# PROFILI PER TENDE DA INTERNI

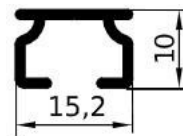
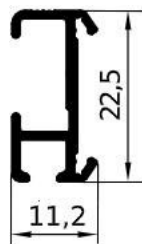
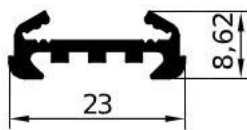
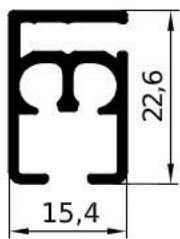

**GA1543 – gr/ml 260**

L/mm.6000

PACCO / 10 BARRE

**GA1604 – gr/ml 168**

VELCRATO L/mm.6000

PACCO / 14 BARRE

**GA1503 – gr/ml 167**

VELCRATO L/mm.6000

PACCO / 10 BARRE

**GA1504 – gr/ml 113**

L/mm.6000

PACCO / 20 BARRE

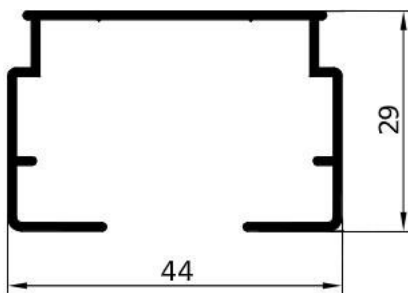

**GA1505 – gr/ml 400**

L/mm.6000

PACCO / 8 BARRE

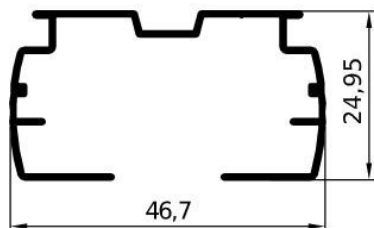

**GA1580 – gr/ml 386**

L/mm.6000

PACCO / 6 BARRE

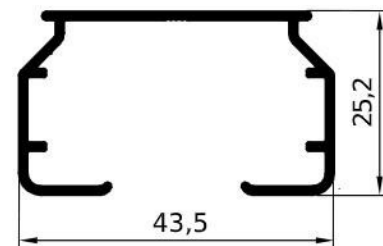

**GA1655 – gr/ml 374**

L/mm.6000

PACCO / 5 BARRE

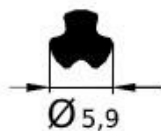

**GA1506 – gr/ml 59**

L/mm.6000

PACCO / 20 BARRE

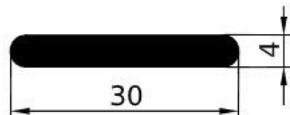

**CPR3004 – gr/ml 315**

L/mm.6000

PACCO / 10 BARRE

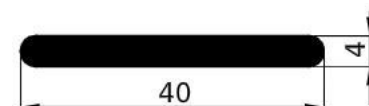

**CPR3003 – gr/ml 423**

L/mm.6000

PACCO / 12 BARRE

# PROFILI PER TENDE DA INTERNI

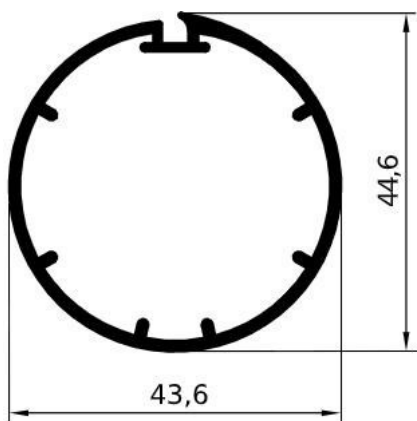

<b>GA1636 – gr/ml 545</b>
L/mm.6000
PACCO / 5 BARRE

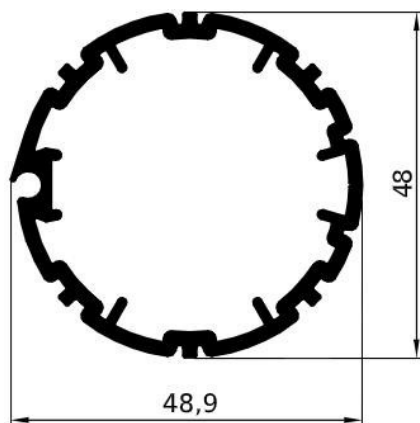

<b>GA1651 – gr/ml 980</b>
L/mm.6000
PACCO / 5 BARRE

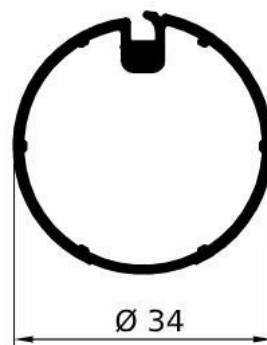

<b>GA1654 – gr/ml 400</b>
L/mm.6000
PACCO / 5 BARRE

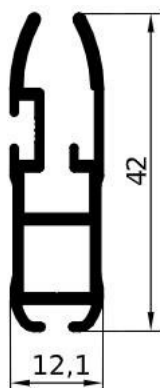

<b>GA1650 – gr/ml 417</b>
L/mm.6000
PACCO / 5 BARRE

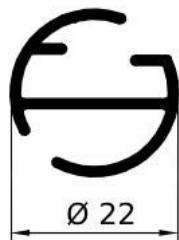

<b>GA1658 – gr/ml 263</b>
L/mm.6000
PACCO / 5 BARRE

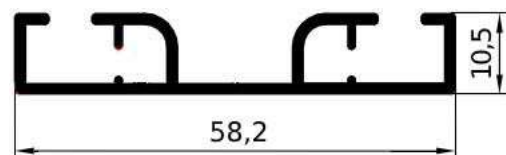

<b>GA1574 – gr/ml 461</b>
L/mm.6000
PACCO / 10 BARRE

# PROFILI SPECIALI

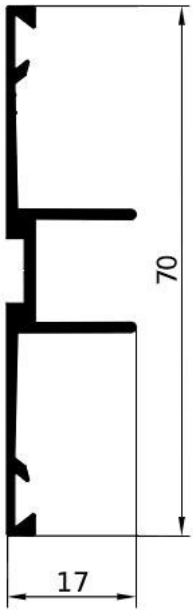

<b>GA1629 – gr/ml 411</b>
L/mm.6000
PACCO / 10 BARRE

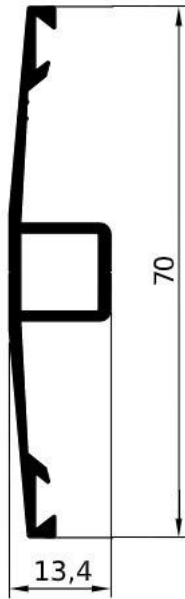

<b>GA1630 – gr/ml 433</b>
L/mm.6000
PACCO / 10 BARRE

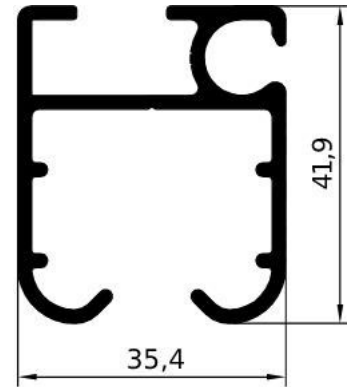

<b>GA1681 – gr/ml 820</b>
L/mm.5000 – 7000
PACCO / 5 BARRE

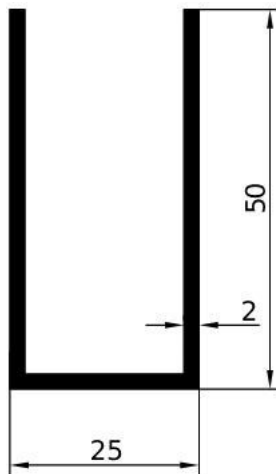

<b>GA1682 – gr/ml 653</b>
L/mm.6000
PACCO / 6 BARRE

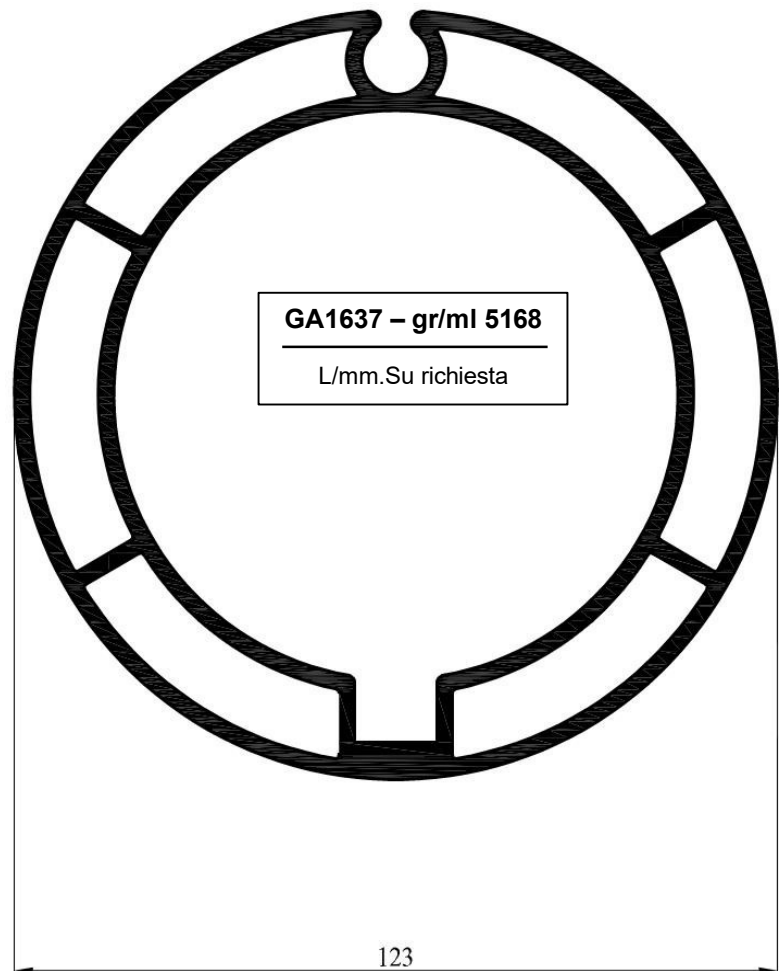

<b>GA1637 – gr/ml 5168</b>
L/mm.Su richiesta

# PROFILI PER ZANZARIERE

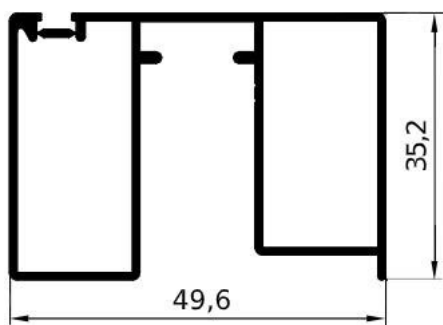

**GA1594 – gr/ml 618**  
**MIN KG.500**

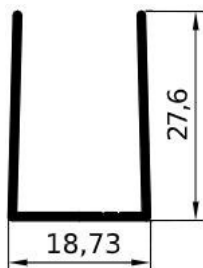

**GA1596 – gr/ml 278**  
**MIN KG.500**

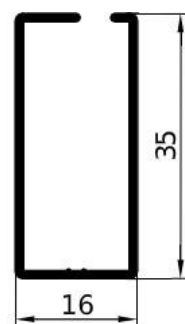

**GA1595 – gr/ml 213**  
**MIN KG.500**

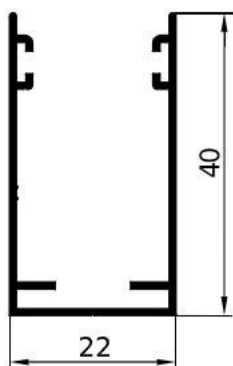

**GA1546 – gr/ml 298**  
**MIN KG.500**

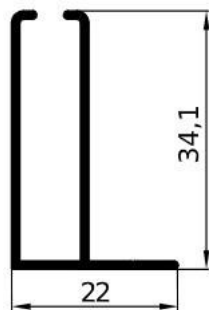

**GA1532 – gr/ml 270**  
**MIN KG.500**

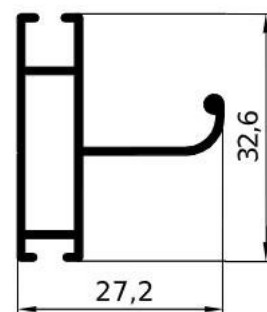

**GA1533 – gr/ml 300**  
**MIN KG.500**

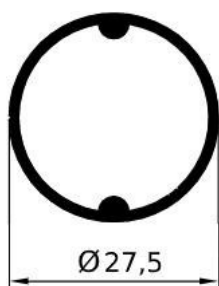

**GA1545 – gr/ml 310**  
**MIN KG.500**

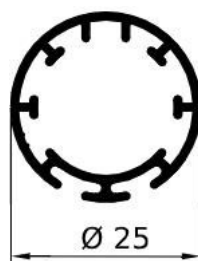

**GA1568 – gr/ml 307**  
**MIN KG.500**



**GA1583 – gr/ml 270**  
 L/barre mm.6000  
**PACCO / 10 BARRE**

# PROFILI PER ZANZARIERE

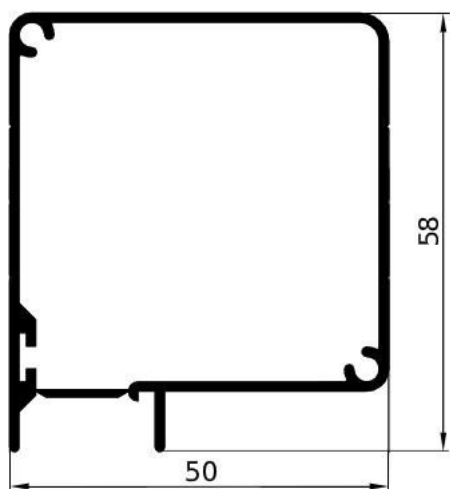

**GA1535 – gr/ml 704**  
**MIN KG.500**

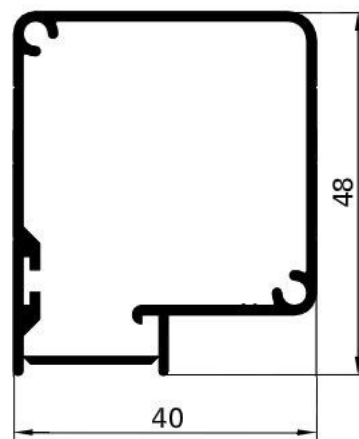

**GA1534 – gr/ml 575**  
**MIN KG.500**

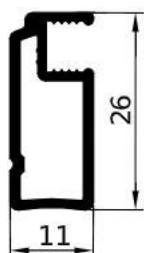

**GA1544 – gr/ml 256**  
L/mm.6000  
**PACCO / 10 BARRE**



**GA1582 – gr/ml 277**  
L/mm.6000  
**PACCO / 10 BARRE**

# PROFILI PER TELONI

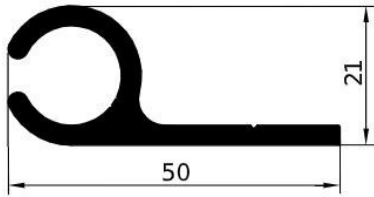

**GA1627 – gr/ml 715**  
L/mm.6000  
PACCO / 6 BARRE

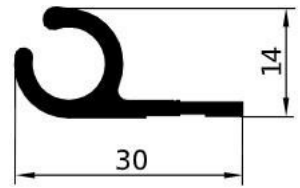

**GA1548 – gr/ml 283**  
L/mm.7000  
PACCO / 10 BARRE

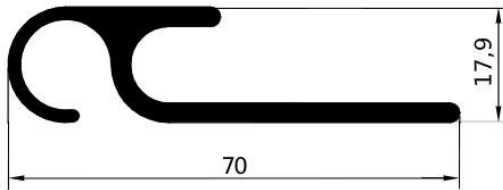

**GA1552 – gr/ml 863**  
L/mm.7500  
PACCO / 4 BARRE

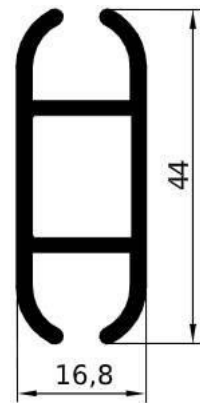

**GA1576 – gr/ml 582**  
L/mm.6000  
PACCO / 5 BARRE

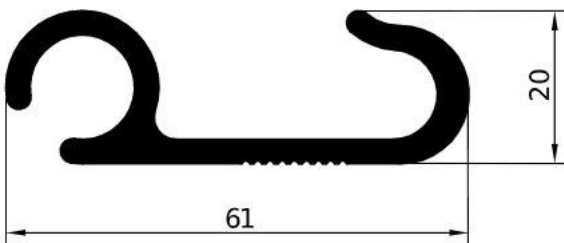

**GA1565 – gr/ml 962**  
L/mm.7500  
PACCO / 6 BARRE

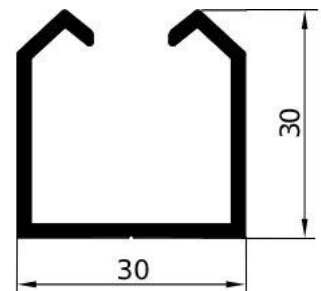

**GA1608 – gr/ml 475**  
L/mm.6000  
PACCO / 10 BARRE



# PROFILI SPECIALI

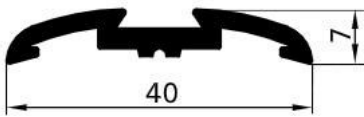

**GA1527 – gr/ml 310**  
L/mm.7000  
PACCO / 20 BARRE

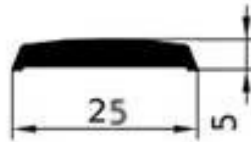

**GA1702 – gr/ml 220**  
L/mm.6000  
PACCO / 20 BARRE

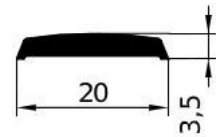

**GA1635 – gr/ml 135**  
L/mm.6000  
PACCO / 20 BARRE

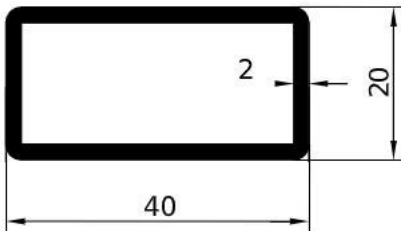

**CTR3022R – gr/ml 597**  
L/mm.6000

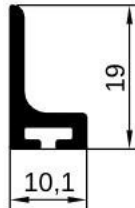

**GA1665 – gr/ml 165**  
L/mm.6500  
PACCO / 10 BARRE

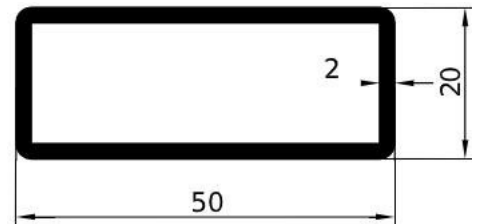

**CTR3031R – gr/ml 705**  
L/mm.6000

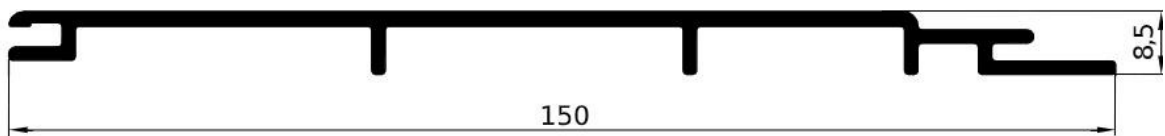

**GA1547 – gr/ml 984**  
L/mm.7500  
PACCO / 2 BARRE

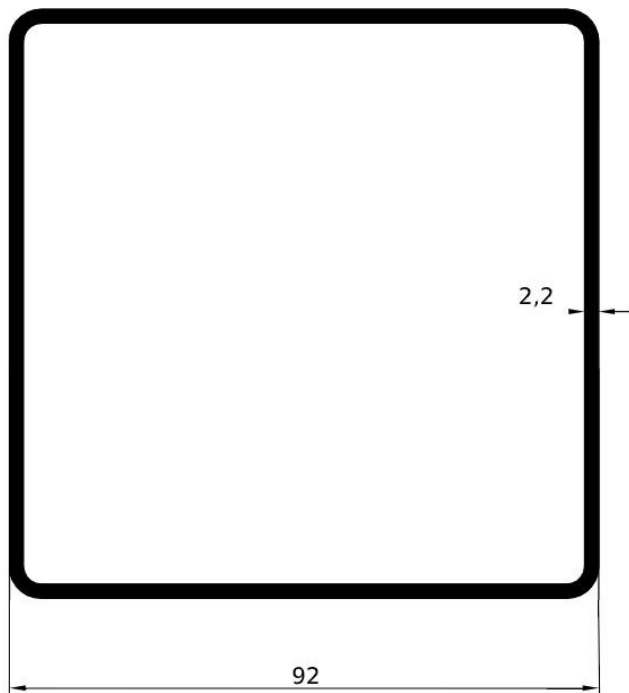

**GA1502 – gr/ml 2095**  
L/mm.4500-5100

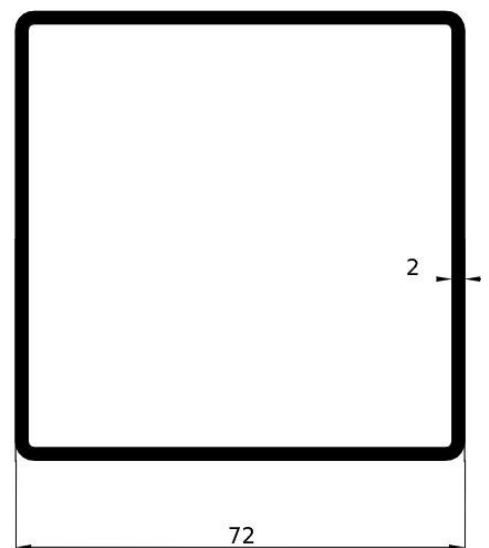

**GA1555 – gr/ml 1495**  
L/mm.5400

# PROFILI SPECIALI

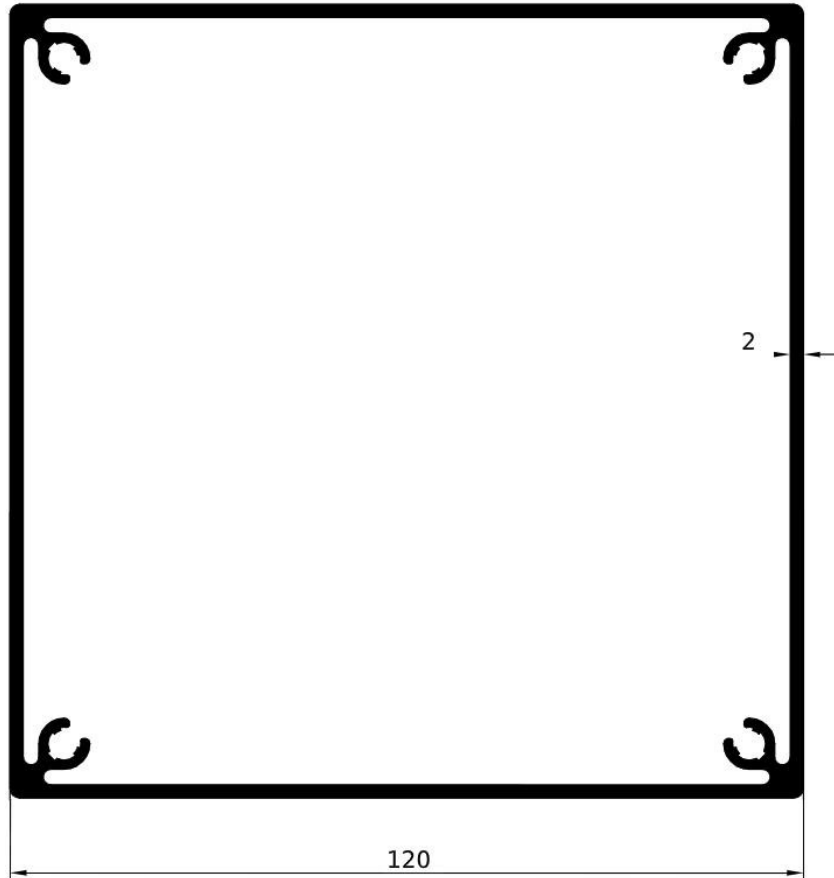

**GA1641- gr/ml 2924**

L/mm.7000

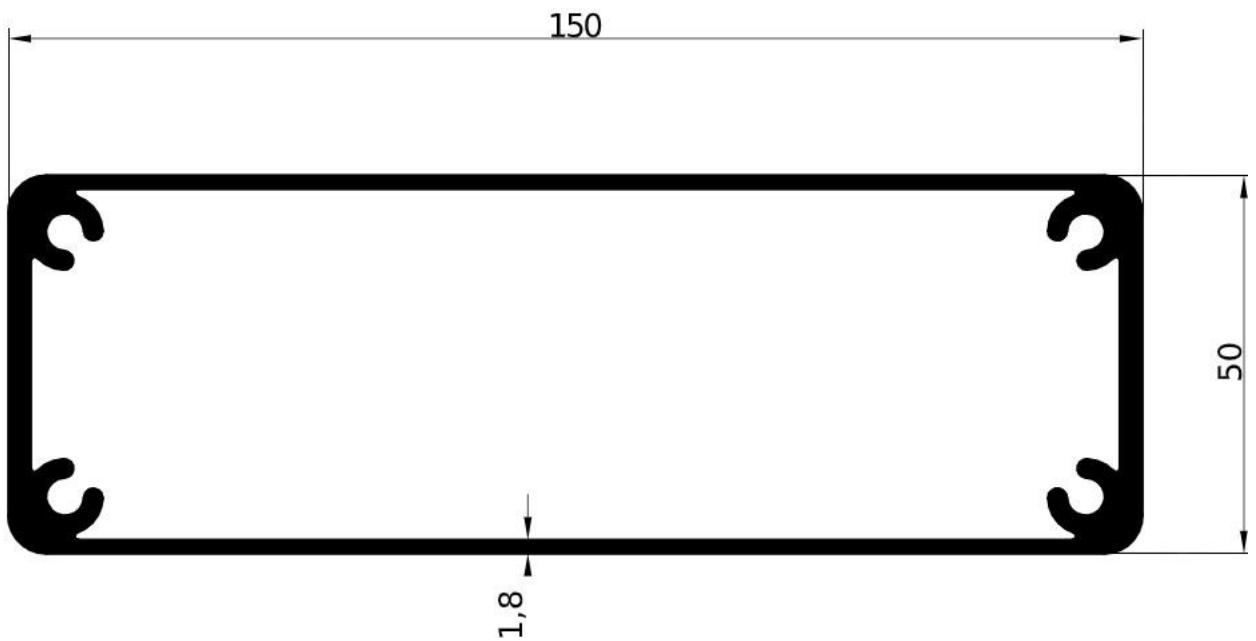

**GA1642 - gr/ml 2751**

L/mm.7000

# PROFILI SPECIALI

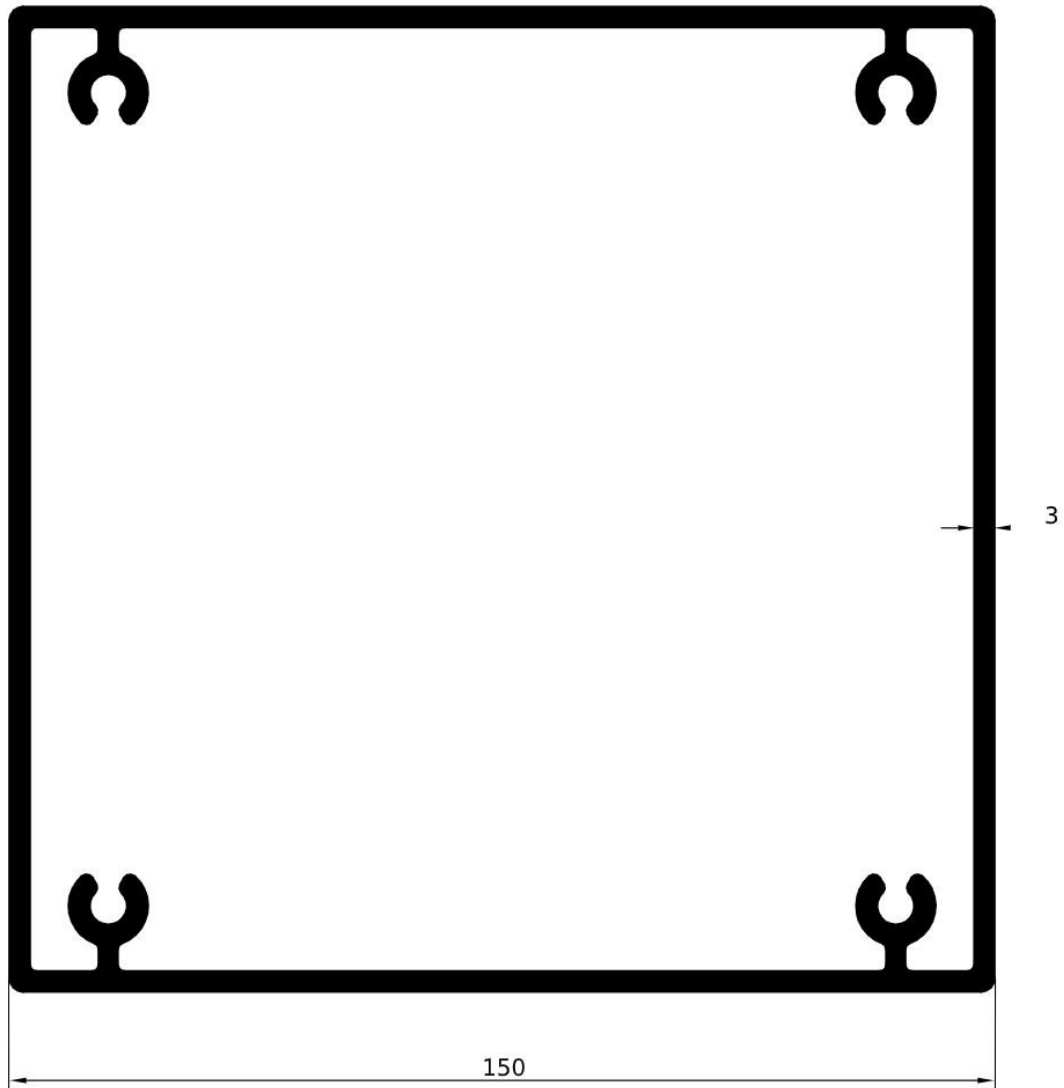

**GA1659 – gr/ml 5655**  
L/mm.7000

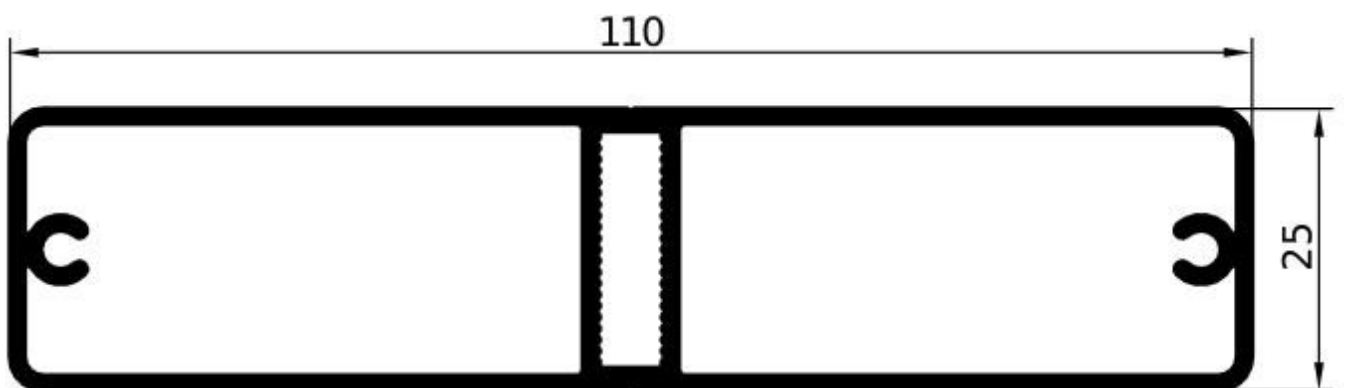

**GA1648 – gr/ml 1194**  
L/mm.6500

# PROFILI SPECIALI

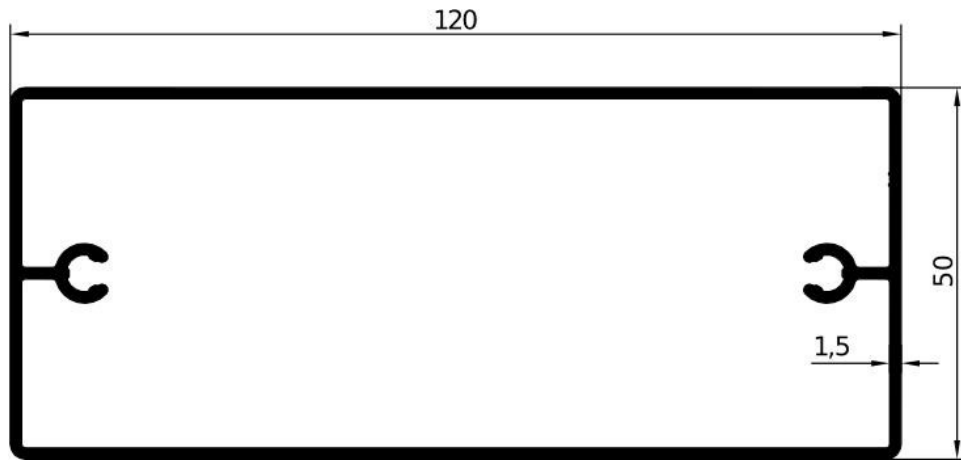

**GA1696 – gr/ml 1522**

L/mm.6000

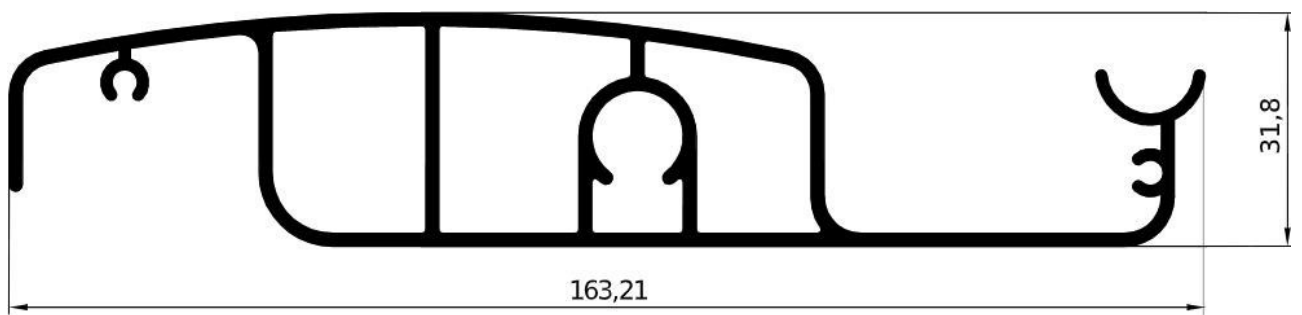

**GAS-232 – gr/ml 2074**

L/mm.Su richiesta

# PROFILI SPECIALI

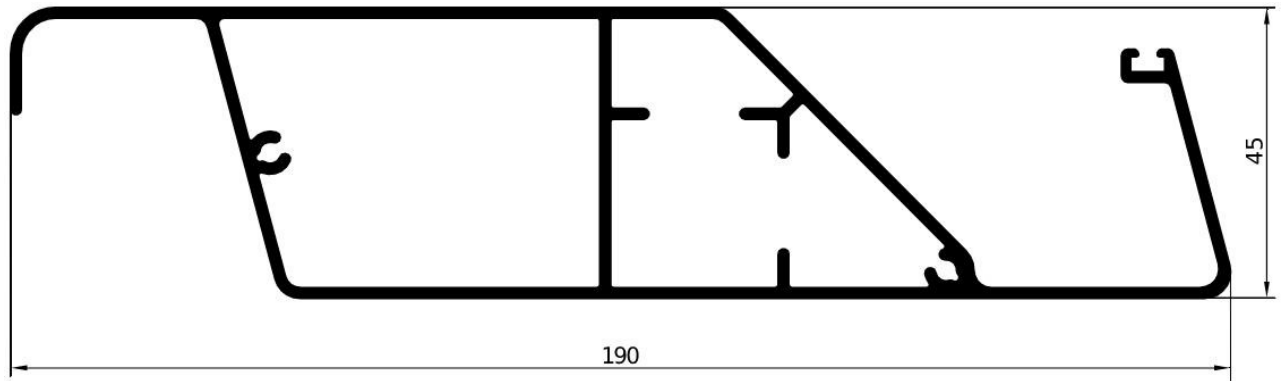

**GA1664 – gr/ml 2085**

L/mm.Su richiesta

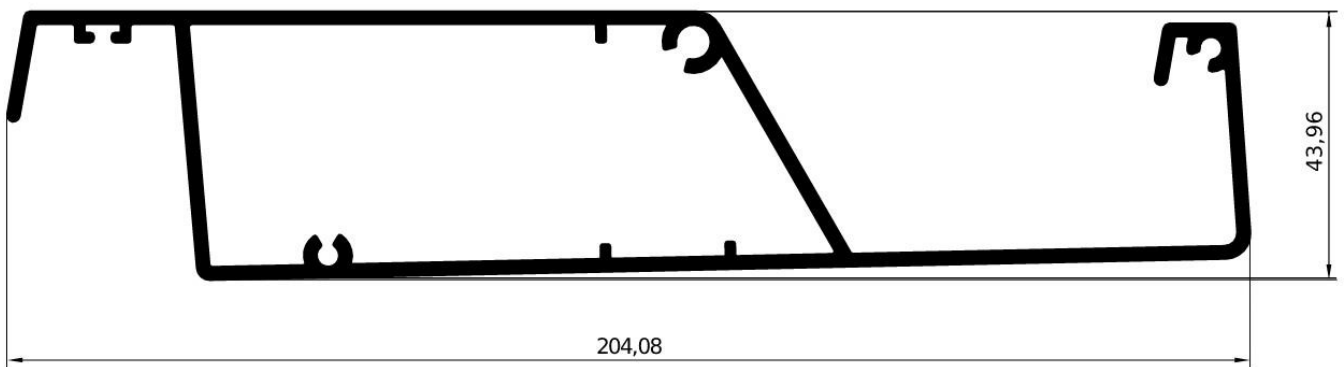

**GA1660 – gr/ml 2584**

L/mm.Su richiesta

# MODULO ORDINI

## GALTAROSSALLUMINIO S.R.L.

Sede: legale e amministrativa: Via del Commercio, 18  
35036-MONTEGROTTO TERME – PD-  
Cod.Fisc e Partita IVA:04545400287  
www.galtarossalluminio.com  
E-mail: [commerciale@galtarossalluminio.com](mailto:commerciale@galtarossalluminio.com)  
E-mail: [amministrazione@galtarossalluminio.com](mailto:amministrazione@galtarossalluminio.com)  
TEL / 049-795363 - Fax 049-795565

ALLA C/A Sig.

Cliente:		
Via ;		
Cap :	Città :	Prov :
Destinazione:		
Spedizione a mezzo:		Resa:
Pagamento:		

Lega: ENAW 6060	Stato fisico: T5	}
Imballo:		

POS.	Cod. GALTAROSSALLUMINIO	Quantità da Ordinare					Tempi di Consegna Prevista	Costo
		N° Barre / Pz	KG	MT	L( mm )	FINITURA		
1								
2								
3								
4								
5								
6								
7								
8								
9								
10								
11								
12								
13								
14								
15								

Data :	NOTE :
Firma :	

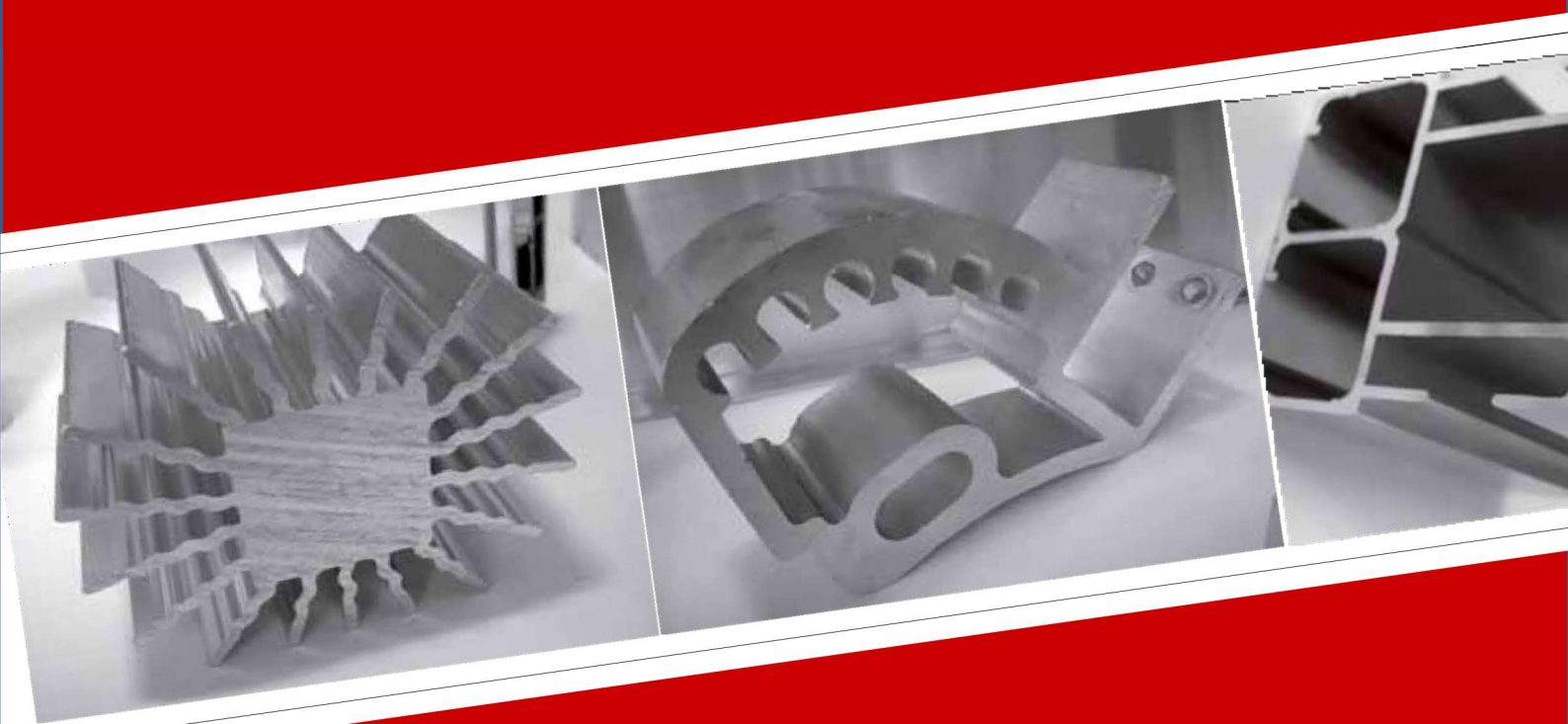

**GALTAROSSALLUMINIO**  
PROFILI SPECIALI

GALTAROSSALLUMINIO s.r.l.  
via del Commercio , 18 35036  
Montegrotto Terme (PD)  
Tel. 049.795363 – Fax 049.795565  
[commerciale@galtarossalluminio.com](mailto:commerciale@galtarossalluminio.com)